



Plexidor® Pet Door Wall Kit Instruction for All Sizes Plexidor®: S, M, L, XL; BiteGuard KennelPlex™ 1113, 1418, 1419 & 1825 and Plexidor® Electronic LG



Congratulations on your purchase of the Plexidor® Pet Door or BiteGuard KennelPlex™ dog door. It will provide you many years of service.

Important Notes:

1. Contractors, Carpenters & Handymen, Please read these instructions. They will save you time.
2. Inside and outside holes in the wall surfaces are **different** sizes and at **different** heights.
3. You may silicone or caulk the outside frame and tunnel pieces. But, **Do Not** silicone or caulk the inside frame of the pet door. If you have multiple dogs or your door receives rough usage, you may need to replace a spring in 5 years. And, we recommend applying a few drops of oil annually to the springs.

Outside Frame

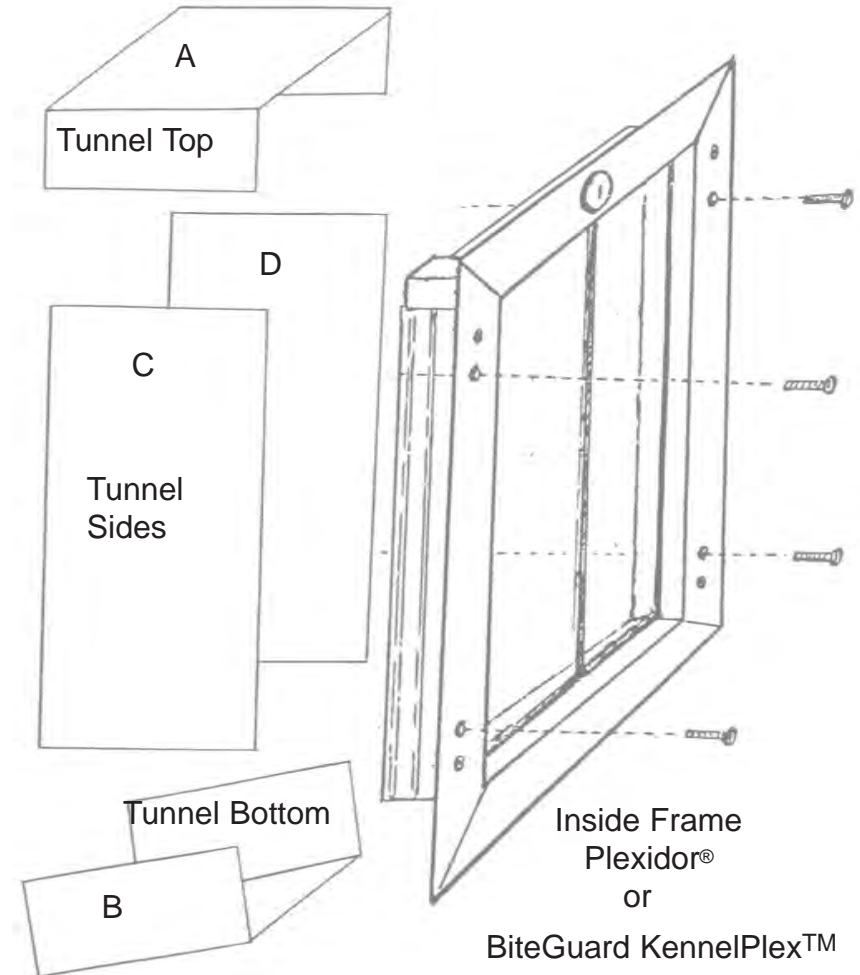
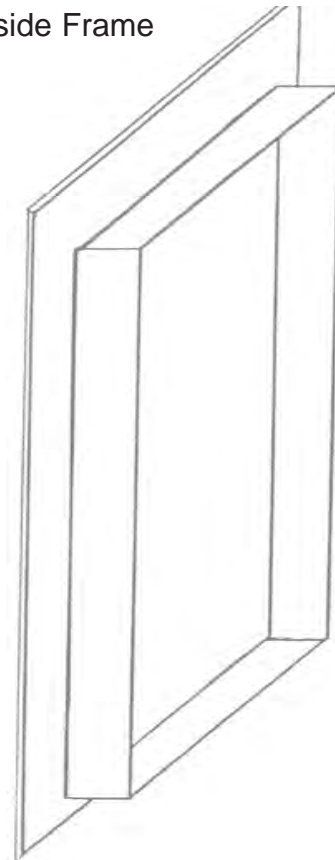

figure 1

Tools Required: Drill & Jigsaw

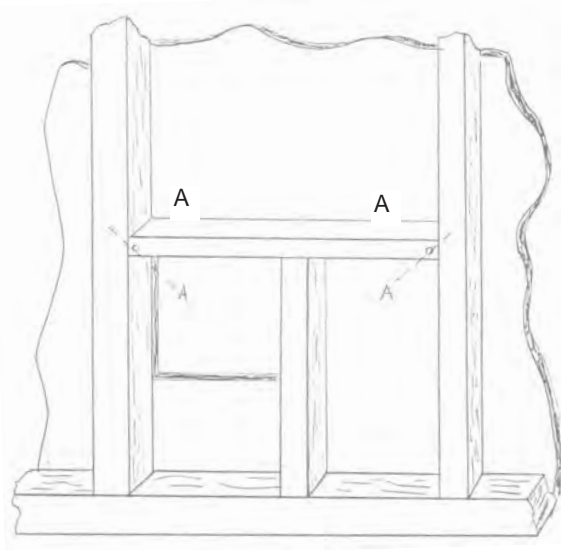

figure 2

Suggested Framing for Size S

Note you do not have to remove the drywall to insert the cross member. Cut the hole for the pet door and insert the cross member through that hole. Then drive screws through the drywall and the 2x4's (2x6's) at points A. Then patch the holes

If framing of the hole is required, the best and usually the easiest way to do this is with the same materials as the framing in your walls, 2x4's, 2x6's. etc. You may frame in the top and bottom of the hole, but it is not required.

Remember to check for and avoid electric wiring and plumbing.

The Size XL and BG KennelPlex™ 1825 do not fit between studs 16 inches on center. If you are going through a load bearing wall contact a local carpenter or contractor.

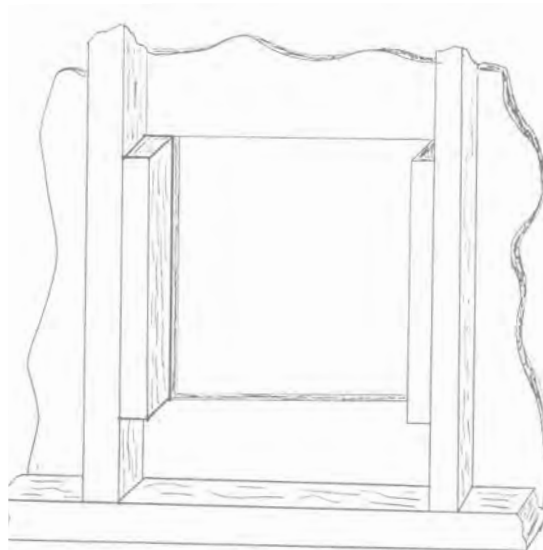

figure 3

Suggested Framing for Size M

This is the typical installation for the **BG 1113** dog door as well.

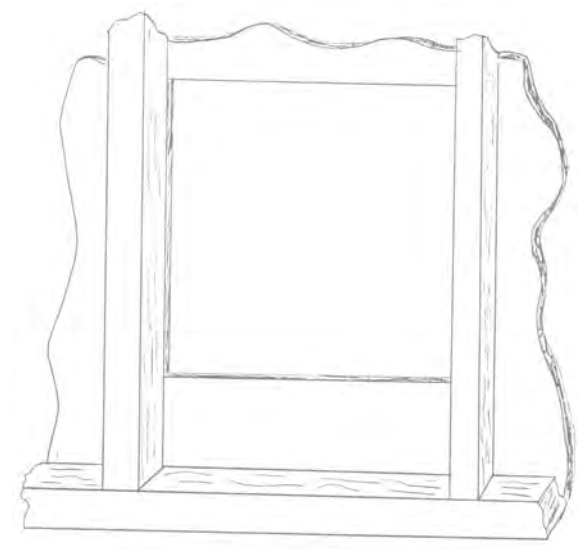

figure 4

Suggested Framing for Size L

Size L fits between studs that are 16" on center. No framing is required.

This is also the framing for the **BG 1418 & BG 1419**

This is the typical installation for the **LG Plexidor Electronic®** pet door as well.

Step #1. Measuring Your Pet.

Measure the height of your pet's shoulders. The ideal height is with the top of the pet door opening 1" to 2" above the pet's shoulder blades. The cat or dog will lift their legs and step through the opening. Any height that is comfortable for your pet will work fine.

If the inside floor level is different than the outside surface you may need to build a step or ramp. Or, you may adjust the height of the hole to a location between the two levels. Test with a piece of cardboard with a hole cut in it and see if your cat or dog can comfortably pass through a hole at that height. You can only cut a hole once. Test the height if in doubt.

Step #2. Cutting Holes

NOTE: The inside and outside holes are different sizes. Line up the top of both holes to the same height. The top of the tunnel will slope up a little. The bottom of the tunnel will slope down so rain and snow will drain to the outside.

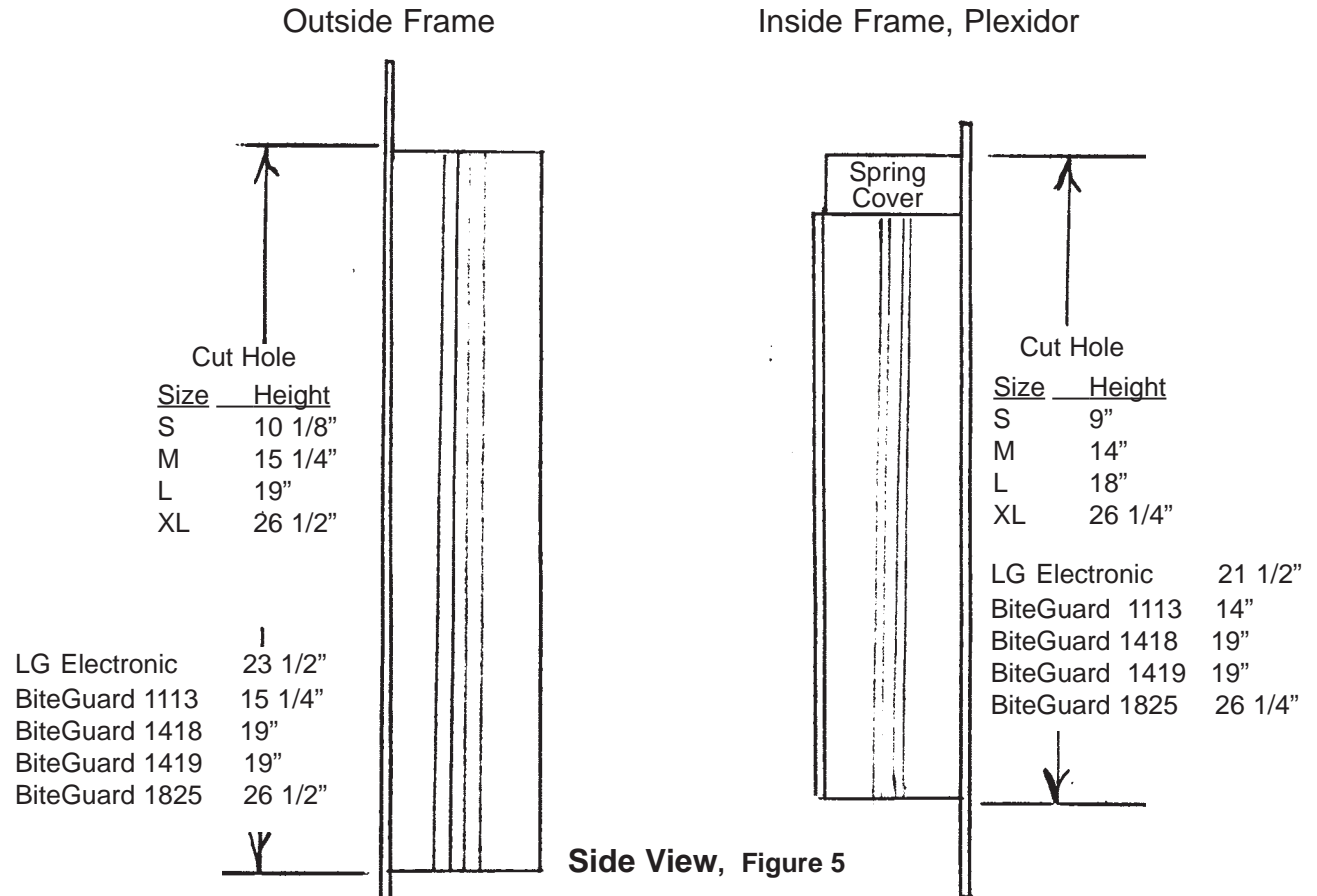

Outside Cut Hole Measurements

Pet Door Size	w "	x "	h"
S	8 3/8		10 1/8
M	11 7/8		15 1/4
L	14 1/2		19
XL	18 1/2		26 1/2
LG Electronic	14 1/2		23 1/2
BiteGuard 1113	11 7/8		15 1/4
BiteGuard 1418 & 1419	14 1/2		19
BiteGuard 1825	18 1/2		26 1/2

Inside Side Cut Hole Measurements

Pet Door Size	w "	x "	h"
S	8 3/8		9
M	11 7/8		14
L	14 1/2		18
XL	18 1/2		26 1/4
LG Electronic	14 1/2		21 1/2
BiteGuard 1113	11 7/8		14
BiteGuard 1418 & 1419	14 1/2		19
BiteGuard 1825	18 1/2		26 1/4

Step #3 Install Plexidor® Pet Door

Install pet door on the inside surface of the wall with 4 screws.

Outside Frame

Inside Frame, Plexidor®

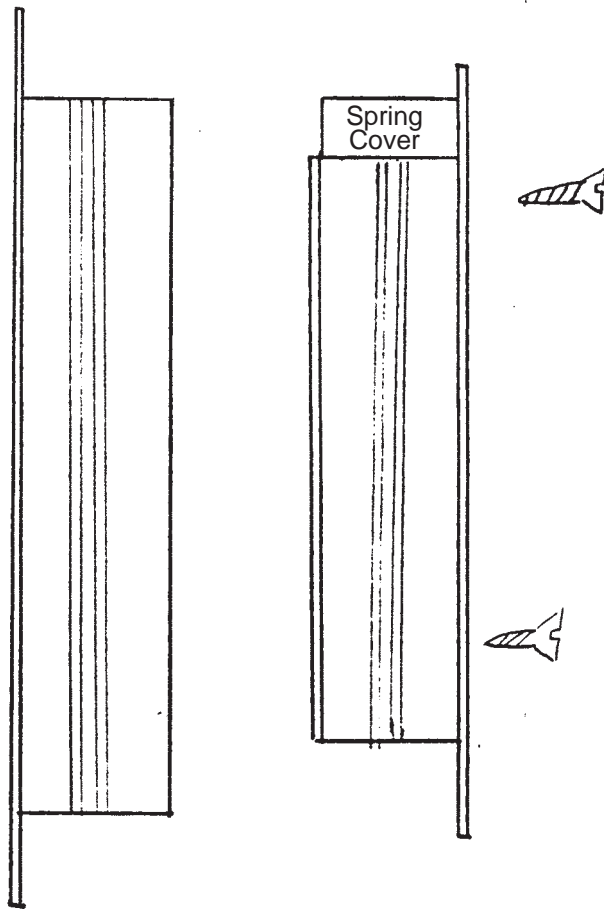

Side View, figure 6

Step #4 Temporarily Install the Outside Frame

You can temporarily install the outside frame with tape. Or you can use 2 flat head screws and screw through the inside edge of the trim piece.

This will allow you to measure and cut the tunnel pieces accurately.

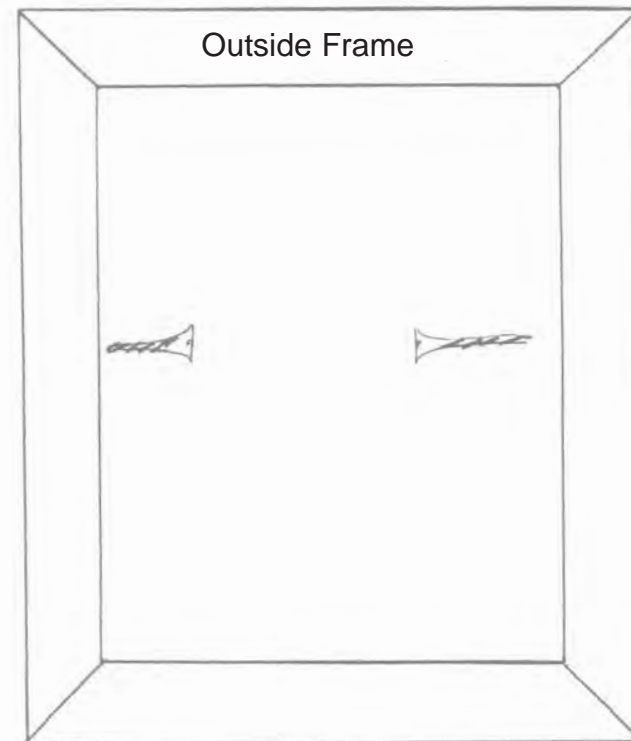

View from Outside of House, figure 7

Step #5 Installing Tunnel Top and Bottom

Hold the top and bottom tunnel pieces in place as shown in figure 8 and mark the outside edge. Cut the tunnel pieces 1/8 inch shorter than your marks. This will cause the edge of the tunnel pieces to be just a little in the tunnel. Cut with the provided aluminum jigsaw blade. Sand cut edges if required. If you are using metal snips to cut the aluminum, first cut a rough cut leaving 1/4 inch of material. Then cut a second time along your cut line. This will give you a smooth and neat finish cut.

Mark here and trim 1/8" shorter than your marks.

Top tunnel piece will rest on small notch that runs along top of the frame of the Plexidor or BiteGuard.

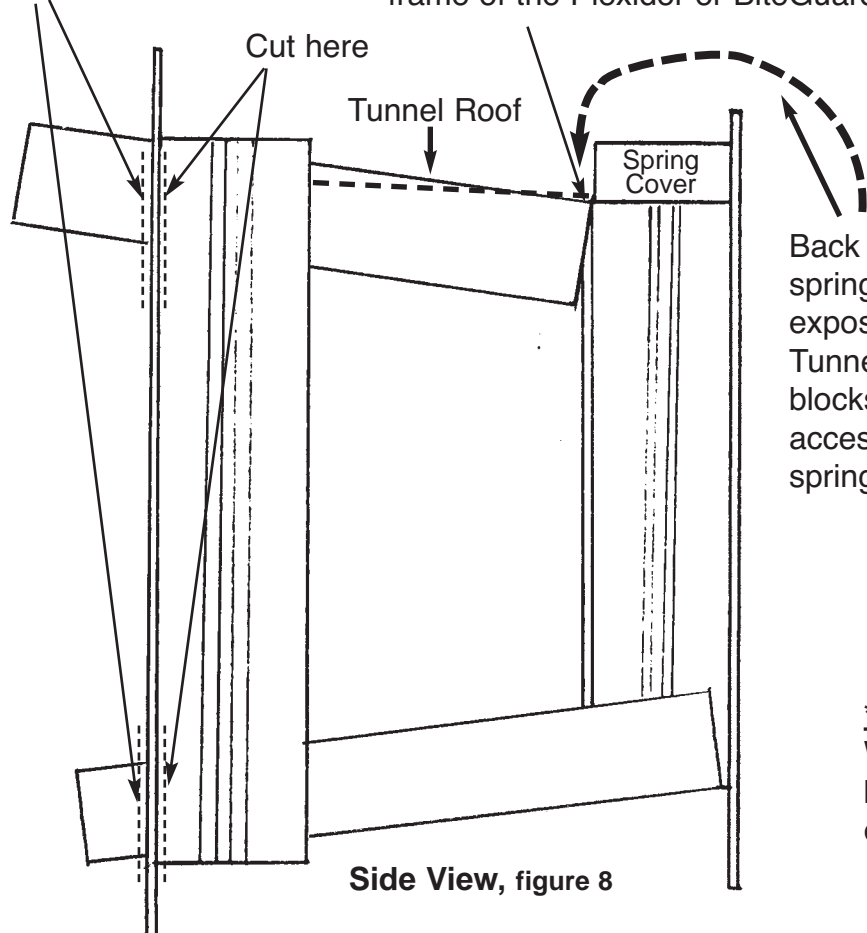

Side View, figure 8

Back of springs are not exposed. Tunnel roof blocks dog's access to springs.

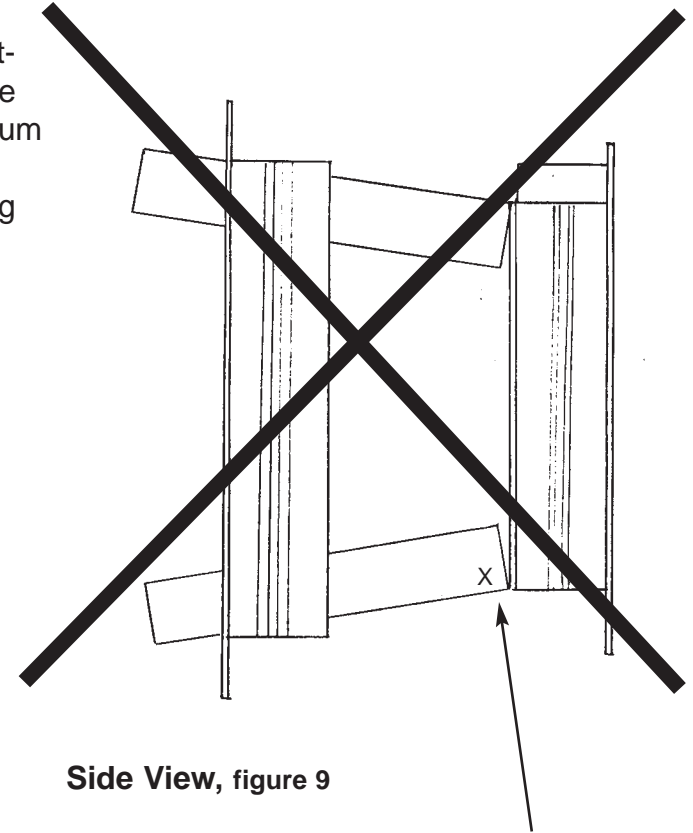

Side View, figure 9

DO NOT DO THE ABOVE

If there is a crack or the metal flexes and creates a crack at point X, a dog or cat will get their claw caught and may injure themselves.

*** Size XL and BiteGuard 1418, 1419 & 1825**

When installing the bottom piece of the tunnel, if there is a bottom lock, do not block the movement of the bottom lock on the dog door.

Screw the top piece in place with 2 flat head stainless steel screws at points A. Screw the bottom piece in place with 2 flat head stainless steel screw at points B. See figures 10 and 11.

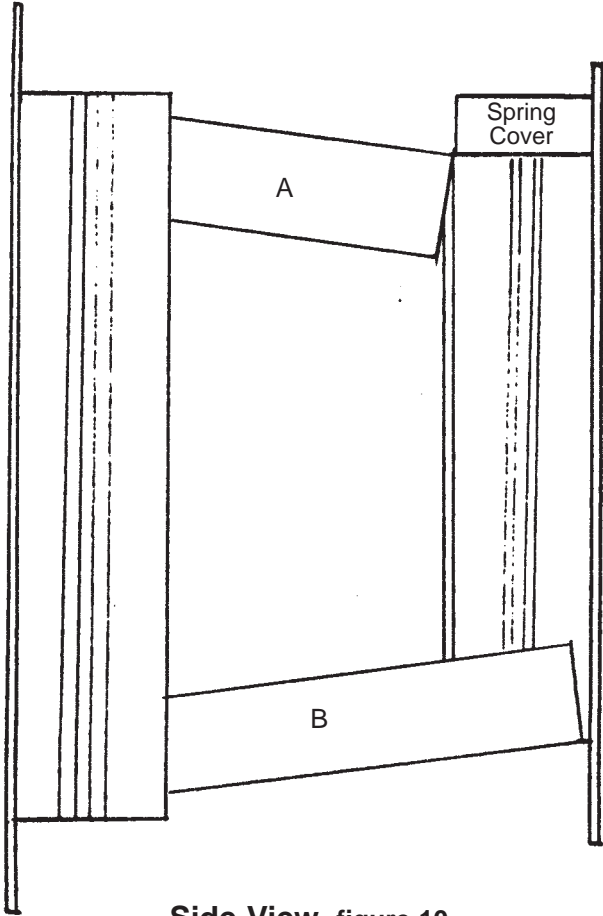

Side View, figure 10

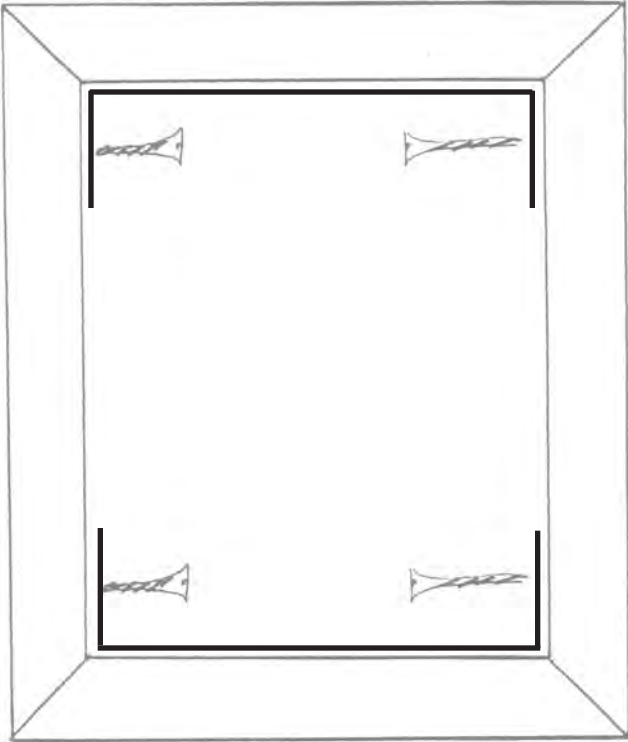

Outside View, figure 11

Step #7 Install Tunnel Sides

Hold side pieces in place. Mark and cut 1/8" shorter than your marks. At this time remove the temporary screws that are holding the outside frame if you installed these. Screw in each sheet with 2 stainless steel pan head screws at points C in figure 12 and 13. If your tunnel is wide, install stainless steel pan head screws at points D. If possible, you may install with the cut edge towards the inside and the factory cut edge towards the outside. This will give a cleaner look.

Mark here and trim
1/8" shorter than
your marks.

Cut here

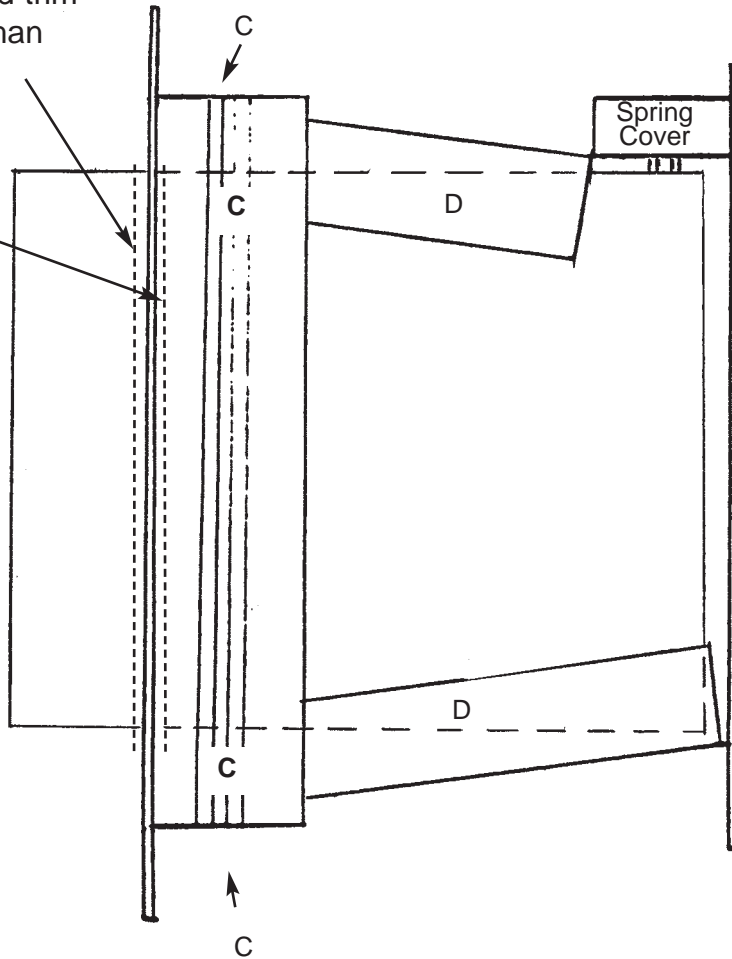

Side View, figure 12

Step #8 Silicone the Joints

Apply silicone between the outside frame and
the tunnel pieces.

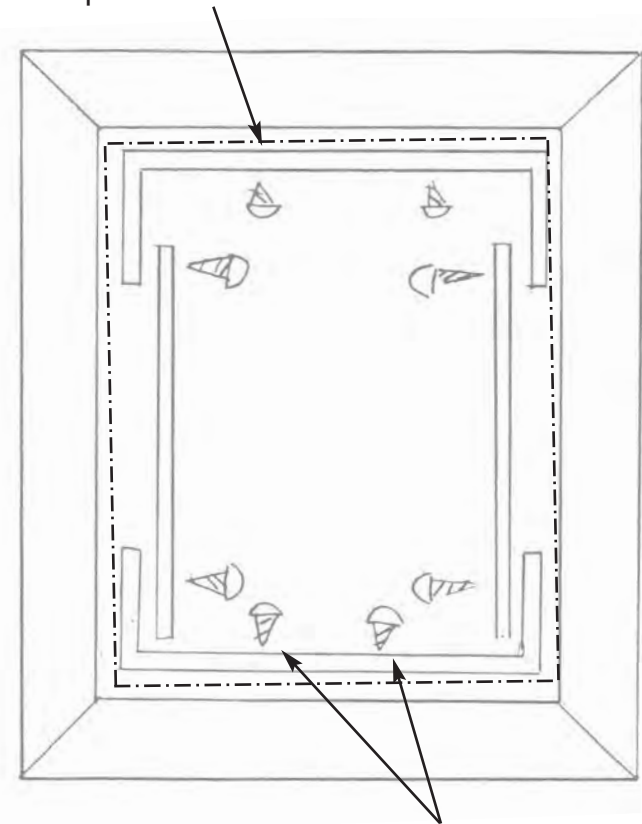

Before installing the 2 bottom screws
put silicone in the screw holes.

Outside View, figure 13

GENERAL CHECK LIST

Notes:

1. Check for Electrical or Plumbing.

2. Cut a test hole.

Cut a test hole in the drywall in the inside of the house that is 6" x 6". Visually check inside this test opening to make sure there is no electrical or plumbing. If you find electrical or plumbing at that time, you can patch the test hole with a 6" x 6" piece of drywall.

Some locations you do not want to go through: right next to doors or right next to windows, because there will be two studs right there, and you do not want to hit those supporting studs. Mounting under a window works very well.

3. Cutting, Taping and Drilling.

After you have checked to make sure there is no electrical or plumbing, complete cutting your hole on the inside of the drywall. The next step is to drill a hole in the upper left hand corner and upper right hand corner at the same height of the hole on the inside. This marks the location of the top two corners of the outside hole. Then tape off the inside hole with masking tape and plastic, so you do not get any mess inside the house. The blue masking tape works best because it will not remove paint or wall paper when removed. Next, go to the outside and cut the hole where you have your top two drill marks. This is the hole for the outside frame. If it is a size small or medium Plexidor®, this is when you would slip in the 2x4's or 2x6's, or other required framing. You do not need to frame the top or the bottom, but you need to frame the left and the right. This is so you have a place to screw in the mounting screws. The size large Plexidor® and Plexidor® Electronic fit exactly between the studs, so you are not required to put any framing in at all.

SIZE XL PLEXIDORS® and BiteGuard KennePlex™ 1825

Extra-Large Plexidor® pet doors and BiteGuard KennePlex™ 1825 do not fit between studding. To properly put an these models in a wall, you need to remove a stud, add 2 jack studs, add a double header over the opening, and then install the pet door underneath this.

INSTALLATION IN BLOCK WALLS

Block installation are possible. Installers do a lot of block walls. The procedure is basically the same. Check for electrical and plumbing on the inside. Cut your 6" x 6" hole through the drywall on the inside and check to see if there are any signs of electrical and plumbing. If you see no signs of electrical and plumbing, then cut out your drywall to the size you need. The next step is to take a hand chisel and score the concrete block left, right, top, and bottom all the way around so that you will not have any spider cracks go into the block that you want to remain. Take the chisel and tap-tap-tap all the way around the cut line. Drill holes in the upper left-hand corner and upper right-hand corner. Tape off the hole inside the house with tape and plastic. Then, go to the outside, and you will have your two holes for your upper left-hand corner and upper right-hand corner. If there is stucco, score the stucco with a rotary blade. A Rotozip with a masonry blade works well. You can also use a skil saw with a masonry blade. Again, scoring that exterior stucco will keep any spider cracks from going into the stucco or chipping away the painted area around the hole. Now you have scored the outside area, and can now drill a hole in the middle so that there is a little relief in pressure when you are breaking this. You can use a hand chisel and chisel it out. Or you can use a rotary hammer, which is like a small jackhammer, to chisel out the block. You work from the middle of the hole to the edges. Chip away a little bit in the middle so you have a place to start, and then work to the outside edges. Again, you have scored the block on the inside and you have scored the block on the outside. So you should not get spider cracks going into the block you want to remain. Once the hole is cut, vacuum up the area and clean it up. Then remove the plastic and tape that is on the inside of the house. From this point on the installation it is similar to the wall installation in a stud wall.

Notes:

ALTERNATIVE METHOD OF ALIGNING HOLE FROM INSIDE TO OUTSIDE

If you think the stucco on the outside of the house will chip when drilling the two top corner holes, use the following method to mark your hole location: Cut the hole on the inside of the house. Align one side of the hole next to a stud. Mark the center of the hole. Drill through the center hole. Then tape off the inside hole with tape and plastic. Use this center hole to measure off of when cutting the outside hole.

INSTALLATION IN BRICK VENEER WALLS

Mark the outside wall first. You want to make the top of the cut on a mortar line. This will keep the top of the hole a nice straight line with no partial bricks. Partial bricks on the top may want to fall out. Do not be concerned with the cut for the bottom of the hole. Cut through the brick with a masonry gas saw using a diamond blade.

Notes:

COLD CLIMATE INSULATION OF WALL UNITS

After the wall unit has been installed remove the interior frame. Spray around the tunnel with “Great Stuff, Window and Door Foam.” You can find this at building supply stores and hardware stores. This foam will expand and fill the gaps around the outside frame from inside the wall. **WARNING** this stuff sticks to everything. If you think it will leak on the outside wall because there are gaps there, put blue masking tape on the outside wall before applying the “Great Stuff Foam.” Spraying this on the aluminum tunnel pieces also greatly reduces sweating condensation on the tunnel walls in the winter. This is great stuff.

UNEVEN WALLS

If the exterior wall is uneven, you can use “Great Stuff Foam” to fill the gaps. Tape off the outside wall area you do not want the foam to stick to. Spray the “Great Stuff” to fill the gaps. Wait for it to dry. This can take an hour, you may want to return later. Cut off the extra with a utility knife. The “Great Stuff” will not rot, bugs will not eat it, it will fill large 1” gaps, and it can be painted.

AREAS OF EXTREME COLD AND/OR NORTH WALLS

If the house is in a really cold area like Minnesota or Alaska, the only good solution may be to install 2 Plexidors®. One on the inside wall surface and one on the outside wall surface. This would be 2 Basic Plexidor® units.

If you have installation problems, please contact your local dealer. They are experienced at installations in local construction. To find an installer in your area call Customer Service at 800-749-9609.

Notes:



**If you have installation problems, please contact your local dealer.
They are experienced at installations in local construction.
To find an installer in your area
Call Customer Service at 800-749-9609.**